

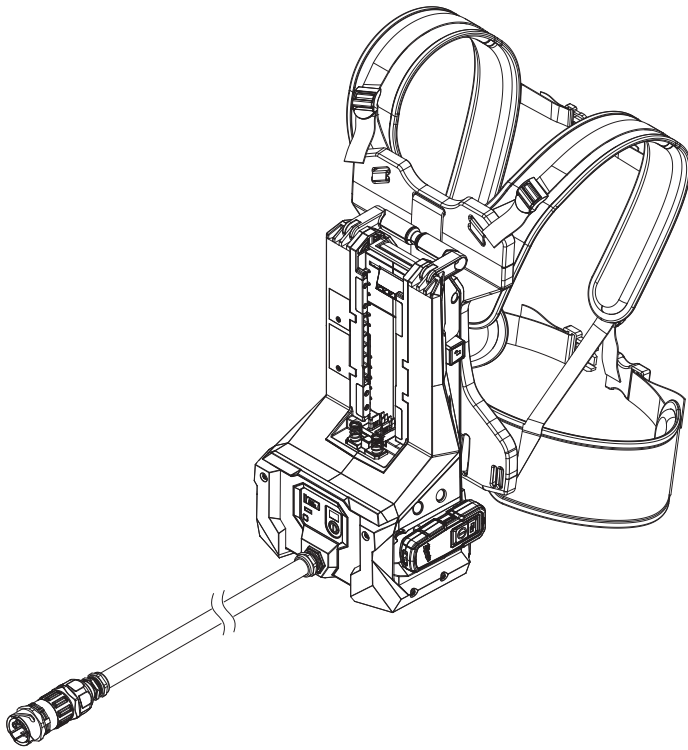

SERVICE PARTS LIST

BULLETIN NO.
54-20-9370

SPECIFY CATALOG NO. AND SERIAL NO. WHEN ORDERING PARTS				REVISED BULLETIN	DATE
MX FUEL™ HIGH CYCLE CONCRETE VIBRATOR					Sep. 2024
CATALOG NO.	MXF372	SERIAL NO.	P48A	WIRING INSTRUCTION See Pages 5-7	



OVERVIEW	PAGE 2
ELECTRONICS Sub-Assembly	PAGE 3
REMOTE Sub-Assembly	PAGE 3
TORQUE CHART	PAGE 3
BILL OF MATERIAL - BOM LISTING	PAGE 4
VCU WHIP ASSEMBLY	PAGE 4
WHIP ASSEMBLY	PAGE 4
WIRING	PAGE 5
WIRING - Continued	PAGE 6
WIRING - Continued	PAGE 7

Only maintenance, service, repairs, and replacements of parts as defined in the Operator's Manual can be performed by the user.

All other repairs are to ONLY be performed by personnel authorized by MILWAUKEE TOOL. Do not attempt to install other parts; this COULD void your tool warranty.

For service, parts, or inquiries, contact us:

- Customer Service at 1.800.SAWDUST (1.800.729.3878)
- E-Service tool repair at: www.milwaukeetool.com/e-service
- Find a local authorized MILWAUKEE service location at Milwaukeetool.com
- Find a MILWAUKEE factory Service Center Location or MILWAUKEE factory Central Repair Center at Milwaukeetool.com. Send the following, posted paid and insured:
 - Your name, address, and phone number
 - Description of the issues
 - Copy of the proof of purchase
 - Tool, charger, and batteries involved with the issues

MILWAUKEE factory Central Repair Centers:

MILWAUKEE TOOL
Central Repair
1401 Sycamore Avenue
Greenwood, MS 38930

MILWAUKEE TOOL
Central Repair
2198 Southtech Drive
Greenwood, IN 46143

MX FUEL HIGH CYCLE CONCRETE VIBRATOR

FIG.	PART NO.	DESCRIPTION OF PART	NO. REQ.
5	1000	Quick-Release Backplate	(1)
21	48-37-0718H	48MM Head and 7' Whip Assembly, Accessory (Not Shown)	(1)
22	48-37-1618H	48MM Head and 16' Whip Assembly, Accessory (Not Shown)	(1)
23	48-37-3218H	48MM Head and 32' Whip Assembly, Accessory (Not Shown)	(1)
31	48-37-0722H	59MM Head and 7' Whip Assembly, Accessory (Not Shown)	(1)
32	48-37-1622H	59MM Head and 16' Whip Assembly, Accessory (Not Shown)	(1)
33	48-37-3222H	59MM Head and 32' Whip Assembly, Accessory (Not Shown)	(1)
200	-----	48MM Head Assembly)	(1)
300	-----	59MM Head Assembly	(1)
400	-----	Whip Assembly	(1)

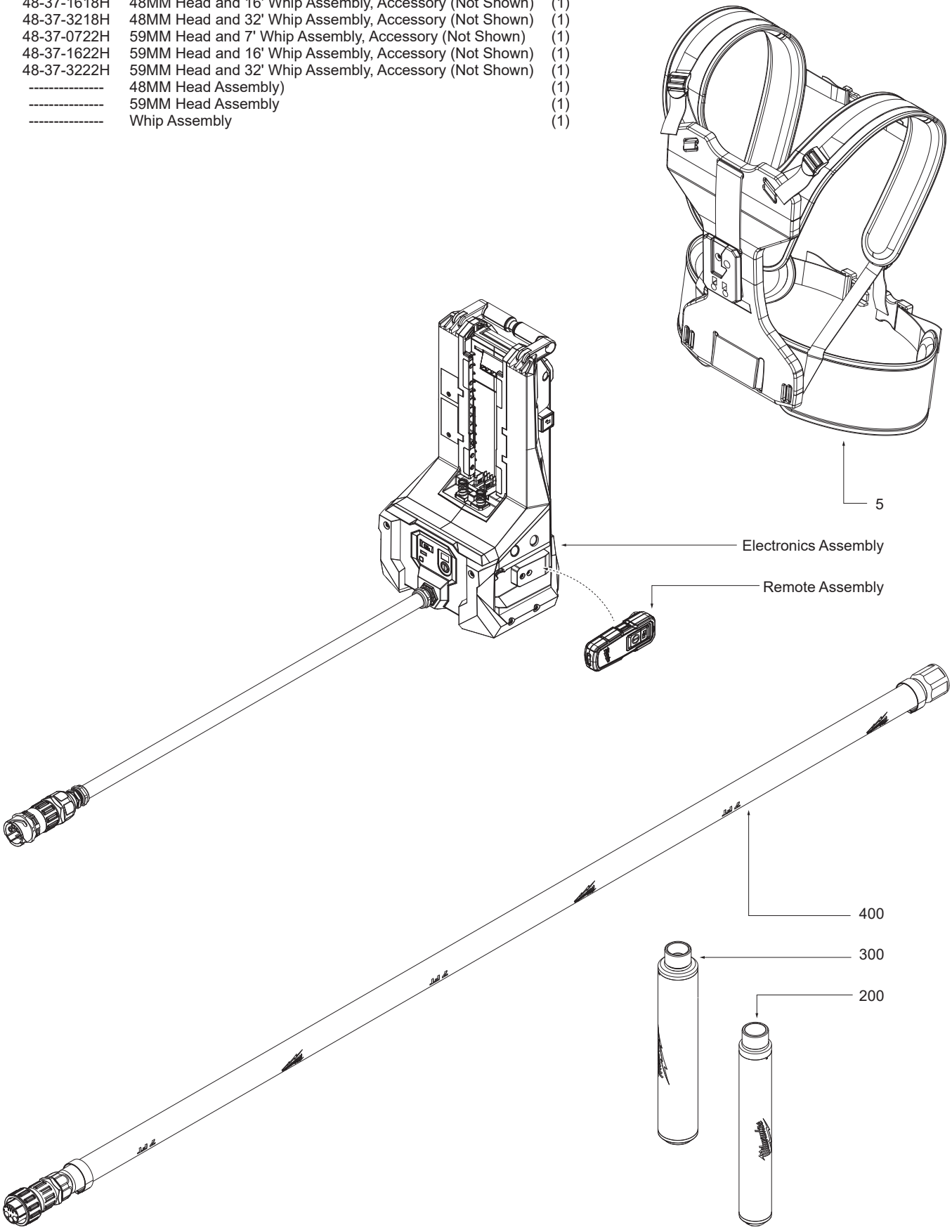

SERVICE BILL OF MATERIAL (BOM) LISTING

FIG.	PART NO.	DESCRIPTION OF PART	NO. REQ.	FIG.	PART NO.	DESCRIPTION OF PART	NO. REQ.
50	14-20-9501	Battery Rails Sub-Assembly	(1)	130	-----	PCBA UI Arm Board	(1)
51	14-46-9969	Left Bracket Kit	(1)	131	3701	Remote Assembly	(1)
52	14-46-9972	Right Bracket Kit	(1)	132	22-68-0211	Pairing Button	(1)
53	14-46-9977	UI Assembly	(1)	133	22-09-2810	PCBA Coin Cell Board	(1)
54	14-46-9976	PCBA Assembly	(1)	134	06-65-7550	Pin	(2)
55	14-46-9973	Ejector Pin Kit	(1)	138	05-88-0087	M5 x 115mm PH Torx T-20 Screw	(5)
56	14-46-9974	Lift Handle Kit	(1)	140	-----	Release Button	(1)
57	23-66-6530	Switch Kit	(1)	142	-----	Remote Bracket	(1)
58	14-46-9971	Remote Bracket Kit	(1)	143	45-60-2135	Reprogramming Header Board Holder Support	(1)
59	14-46-9340	Reprogramming Header Cover Assy	(1)	147	-----	Compression Spring	(1)
60	14-46-9335	Coin Cell Cover Assembly	(1)	151	06-82-0095	M4 x 16mm Cap Hd. Screw	(18)
61	31-21-0041	Battery Cover Assembly for Remote	(1)	153	05-88-5375	M4 x 13.5mm Pan Hd. Torx T-20 Screw	(2)
101	-----	Coin Cell Battery (CR2032) - See local hardware store	(1)	154	06-82-0029	M5 x 16mm PH Torx T-25 B Screw	(4)
102	42-42-4010	Arm Button	(1)	157	06-82-0027	M3 x 7mm Pan Hd. Torx T-10 Screw	(4)
104	-----	AAA Battery	(2)	158	06-82-3002	M3 x 10mm PH Torx T-10 B Screw	(12)
105	-----	Left Bracket	(1)	159	-----	Switch Bezel	(1)
106	-----	Right Bracket	(1)	160	-----	Switch Cover	(1)
107	42-38-9060	Left Bumper	(1)	161	-----	Switch Pockett	(1)
108	42-38-9065	Right Bumper	(1)	163	10-20-7259	UI Label	(1)
110	14-20-9485	Coin Cell Pocket Holder Support	(1)	164	-----	UI Panel	(1)
114	34-60-0401	E-Ring	(2)	165	40-20-6707	UI Power Label	(1)
116	45-88-0377	Flat Washer	(16)	166	14-20-9490	Wire Assy for Vibrator Switch	(1)
118	-----	Handle, Folding	(1)	168	14-20-9495	Wire Assy of Cable & Connector Assy for Control Board	(1)
119	31-44-7265	Housing Cover Assy	(1)	171	10-22-0670	Warning Label	(1)
120	31-50-8990	Housing Front Panel	(1)	172	12-20-9975	Service Nameplate	(1)
121	31-44-7157	Housing Support Assy	(1)	200	-----	48MM Head Assembly	(1)
122	42-92-7110	Latch Cover VCU	(1)	300	-----	59MM Head Assembly	(1)
125	-----	Locking Pin	(1)	401	-----	7 ft. Whip Sub-Assembly	(1)
126	31-01-9120	Logo Plate	(1)	402	-----	16 ft. Whip Sub-Assembly	(1)
127	06-82-9820	M6 x 7mm CH M Screw	(5)	403	-----	32 ft. Whip Sub-Assembly	(1)
128	-----	Jiaben K2 Switch	(1)	422	12-20-9906	Service Nameplate for Whips	(1)
129	-----	PCBA Control Board Assy	(1)				

VCU WHIP ASSEMBLY

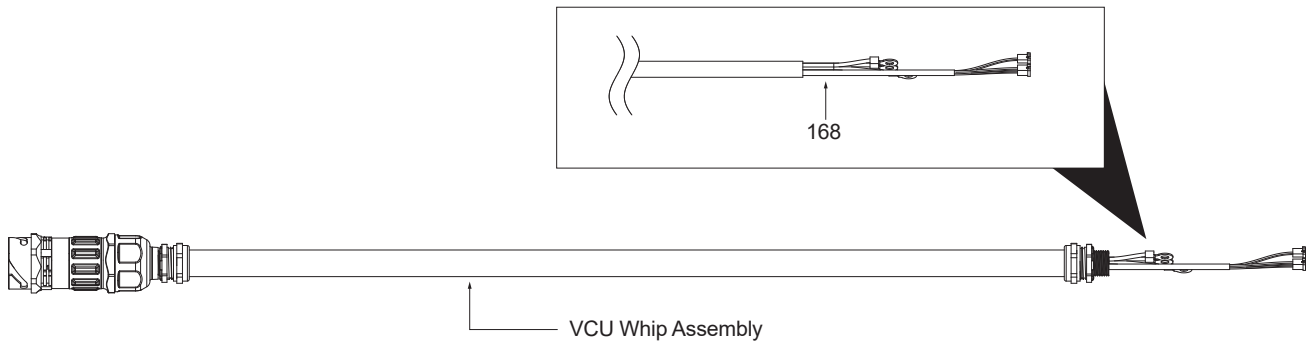

WHIP ASSEMBLY

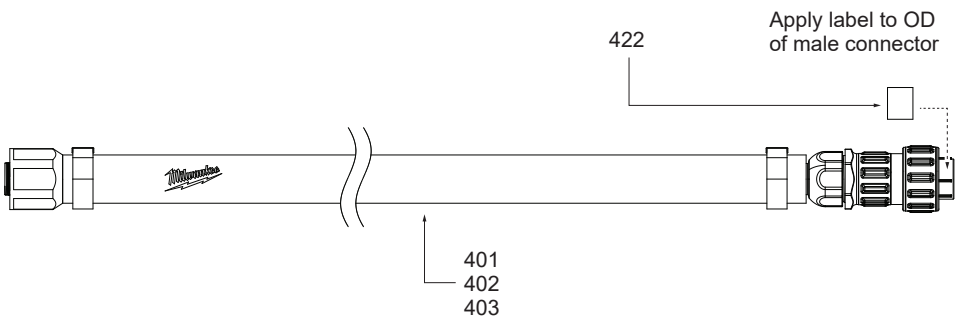

WIRING



1. Remove nut and rubber washer from connector assembly.
2. Thread Cable through the front panel.
3. Insert rubber washer and nut.
Torque to 32.5 ± 2.5 kgf-cm (28 in-lbs)

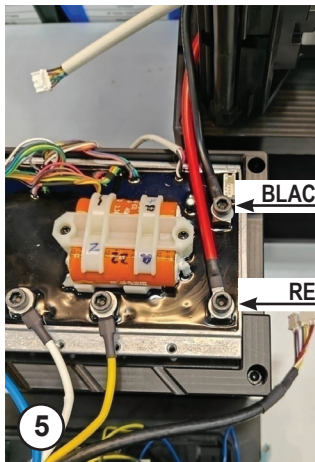
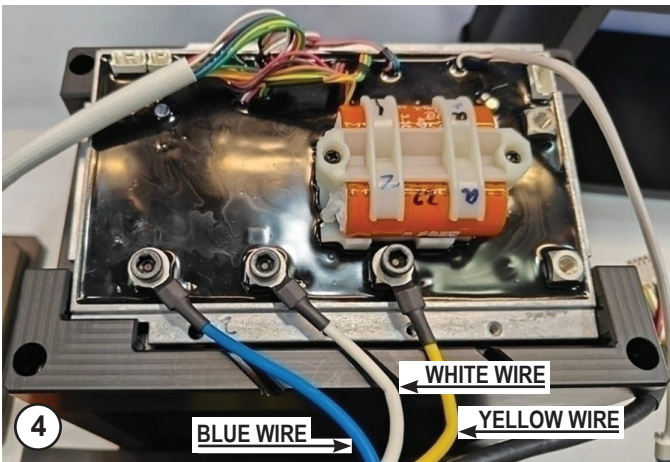
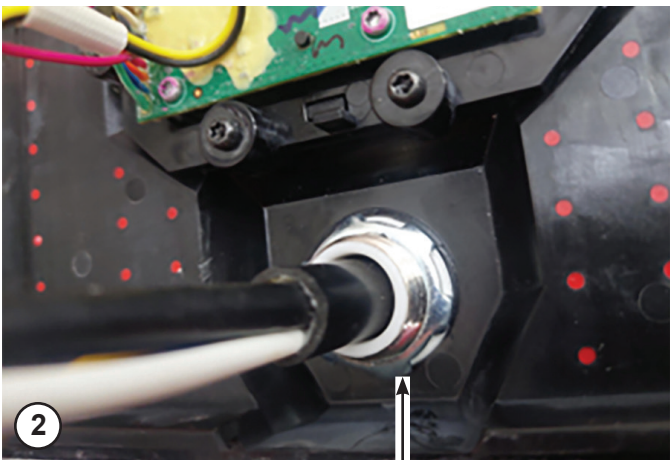

4. Attach phase wires to PCB using M6 Screws in order shown.

5

5. Attach battery to the red and black wires as shown.

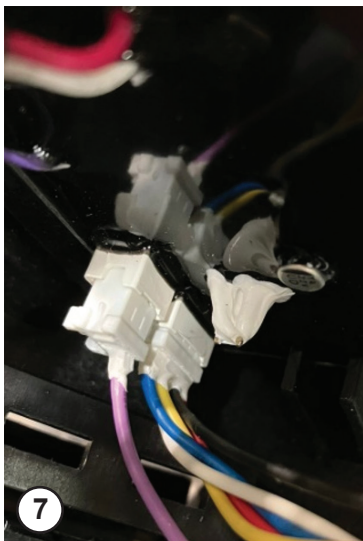
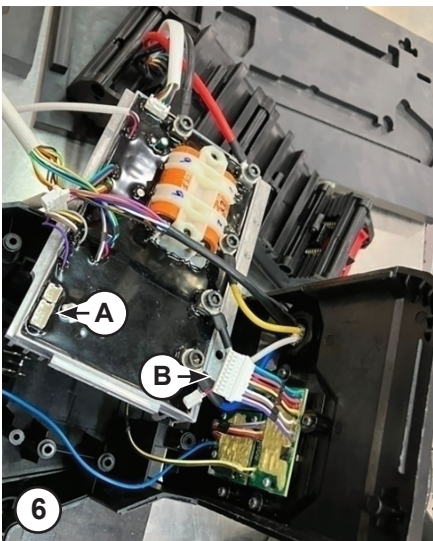

- 6A. Fill two female connectors on PCB with dielectric grease to cover pins.
- 6B. Plug male hall wire connectors from wire harness.
7. Verify connectos are fully seated.

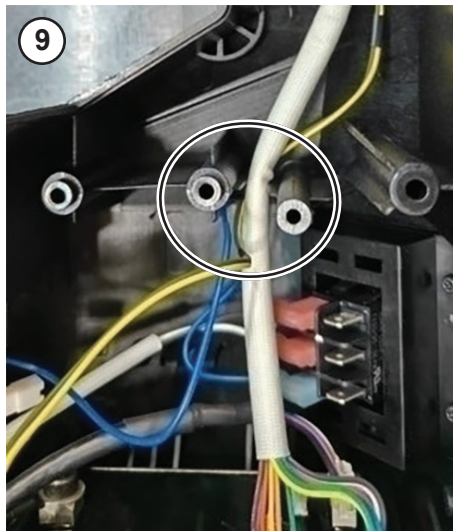
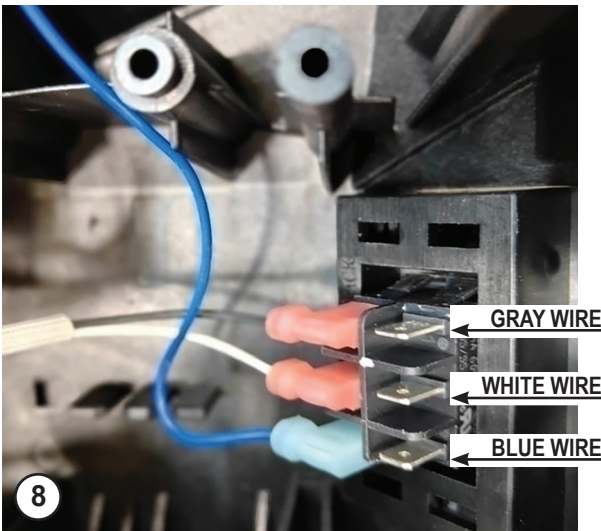

8. Attach switch wire harness blade clips in order shown.
9. Make sure wires are routed as shown.
10. Verify battery is inserted in orientation shown.
11. Attach black/yellow wire clip to 3V battery PCB.
12. Route 3V battery wire through housing as shown. Verify wire is fully seated in wire traps.

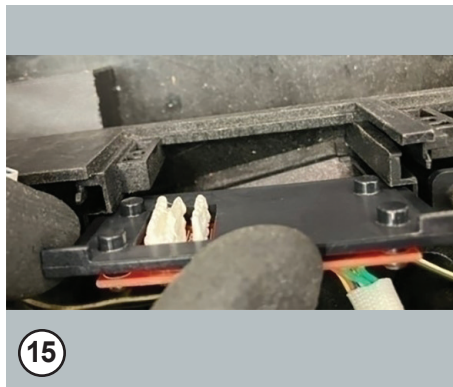
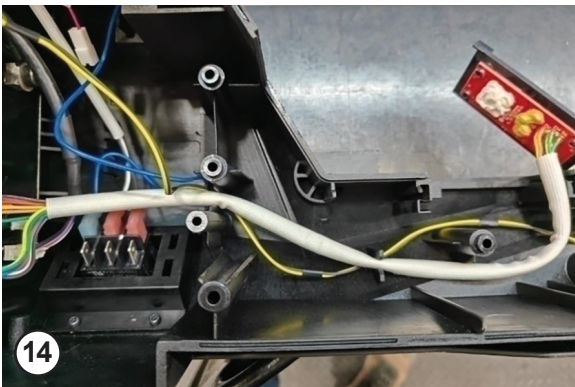
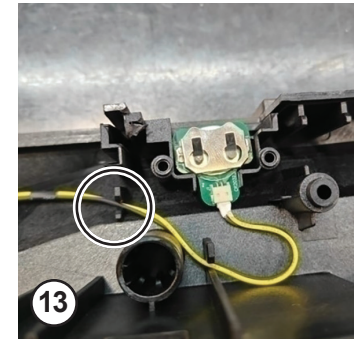
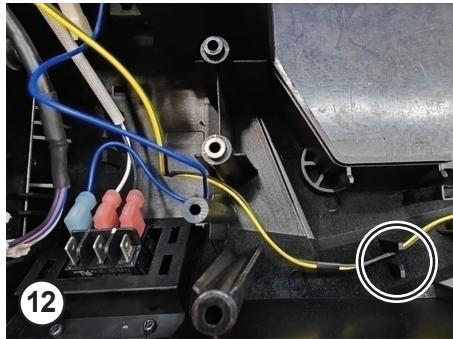
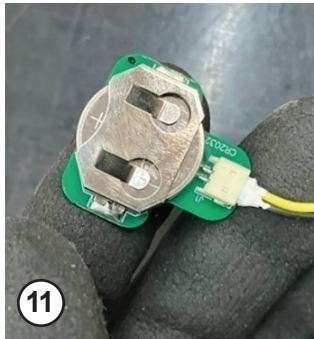
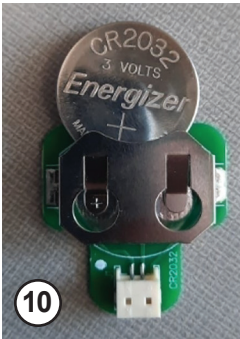

13. Place 3V battery PCB in housing half slot as shown.
14. Route rework PCB in housing. Verify wire bundle is fully seated in wire traps.
15. Place rework PCB in housing slot in orientation as shown.



16. Add dielectric grease to 3 pin connector from switch harness.
17. Locate connector in housing slot as shown.
18. Fully seat 3 pin male side connector from PCB assembly.

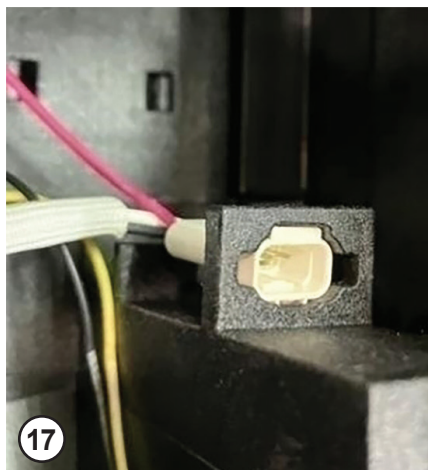

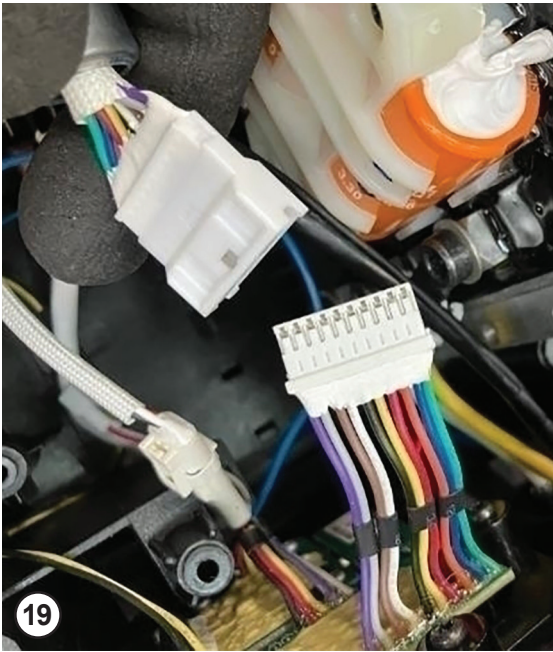

19

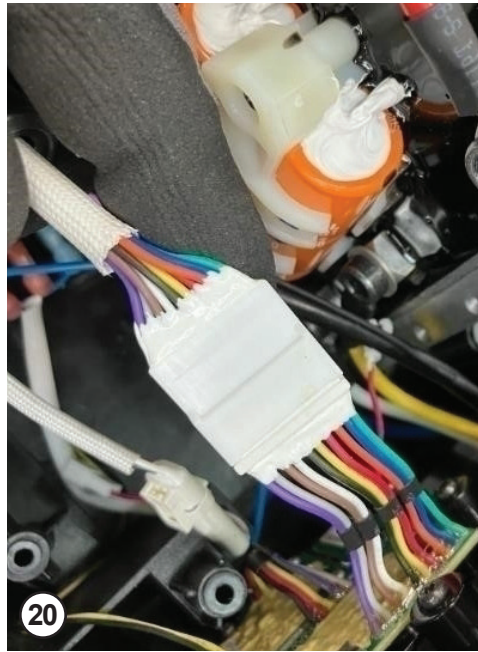

20

19. Add dielectric grease to large connector from PCB to cover pins.
20. Connect to male connector from UI PCB as shown.
21. Add dielectric grease to cover pins to single red wire connector.
22. Fully seat connector with single red wire from UI PCB.

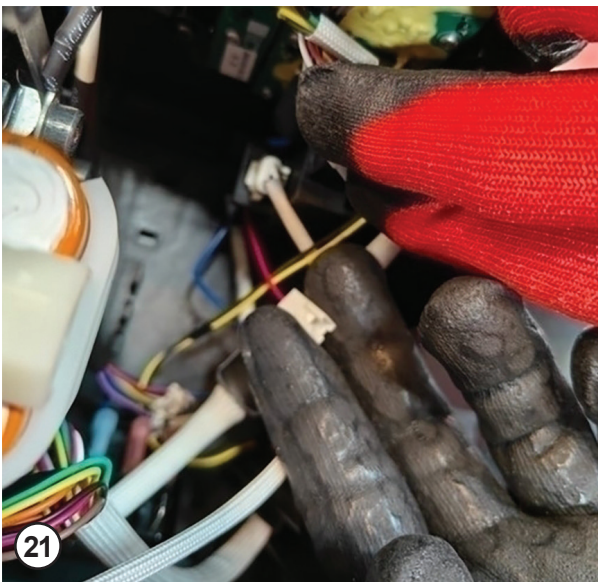

21

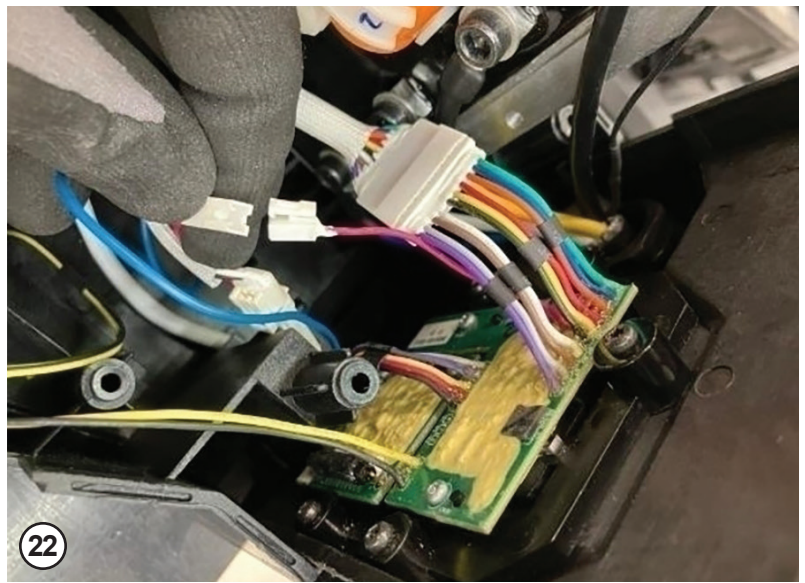

22

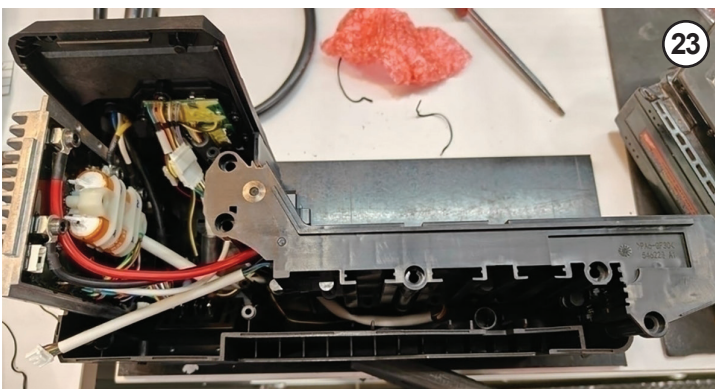

23

23. Add dielectric grease to cover pins in remaining female connector on PCB.

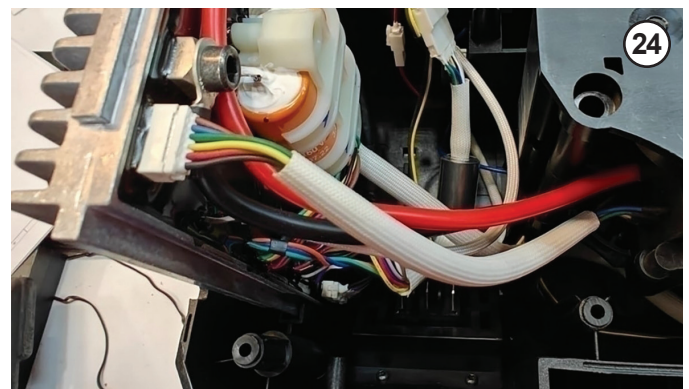

24

24. Fully seat wire bundle connector from battery rail.